

Wilga 30cc

Assembly Manual



Caution!

You should not regard this plane as a toy!

To ensure safety, please read this instruction manual thoroughly before assembly.

Building and operating a model plane requires diligent practice and correct guidance. An inexperienced flyer can cause serious injury and property damage.

Seek the assistance of an experienced RC pilot or model airplane club for help with assembly, operation and maintenance to ensure your flying experience is both enjoyable and safe.

Fly only in AMA (Academy of Model Aeronautics) approved areas. Approved areas or areas approved by the Model Association of your country.

Note: the accessories coming with airplane may not same as below list. Please inquire it with the distributor.

Fuselage parts

Rudder Horn



M5x3



M3X16 Socket Screw



Tail Wheel Set



M3 Pull-Pull Coupler

Ball Link-L



Cowling Canopy

M4 Washer



M3X20 Socket Screw



M3X16 Self Tapping Screw



Landing Gear

M4X20 Socket Screw 6



M4 Washer



M4 Lock nut



Pu Wheel 3.5"



Hook & Loop Fastening Tape



380CC Fuel Tank



Throttle Servo Tray



2mm Linkage Stop 1



2X200mm Throttle PushRod

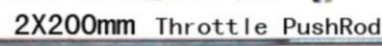

Main Wing parts

M6X22 Nylon Screw 2



Carbon Wing Tube 24X26X1000mm



Ball Link-L



3X65mm Push Rod



Control Linkage



Elevator parts

M3X16 Screw



Ball Link-S



Control Linkage





Rudder parts

Dia. 0.6mm Wire 1100mmX2

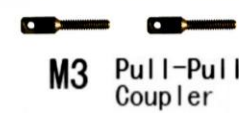

M3 Pull-Pull Coupler



4X16 Socket Screw



Cable Copper Fixer 8



Ø2mm



M4X142



Ball Link-S



Carbon Stab Tube 6X8X196 mm



TOM 2013.6.15

wilga 89in Airplane Accessories

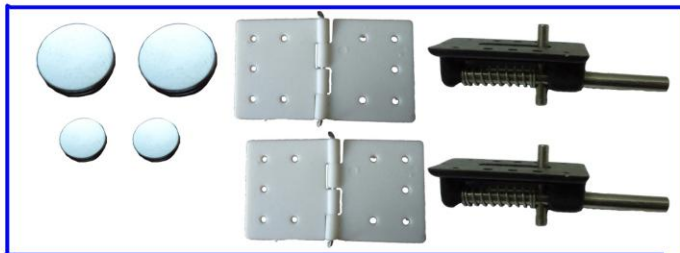
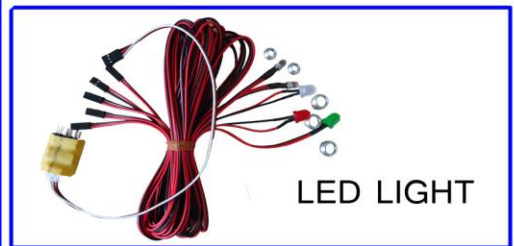
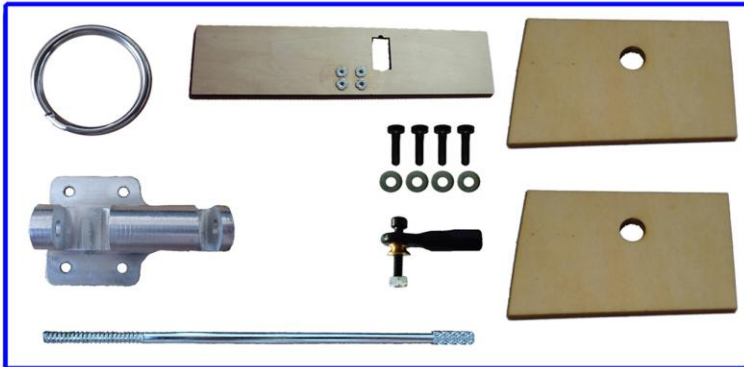
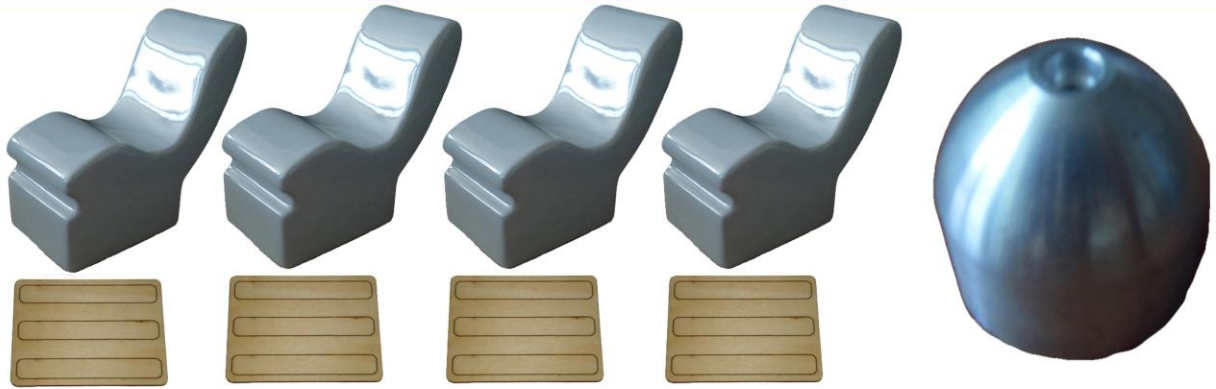

Main Landing Gear Installation

Install the landing gear into the fuselage by screws as shown.

Lock the wheels onto the landing gear by wheel axles.



LED light

Find out the LED light system.

Insert the LED light into the holder as shown.

Find out the holes for the LED light in the wings and rudder.

The voltage for the light is 6V.

Find out the hole for the LED light on the top of the rudder and cut it out.

Insert the LED light wire from the top of rudder, and glue it onto the rudder.

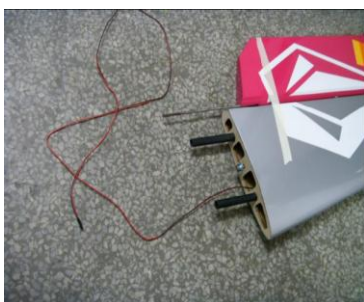
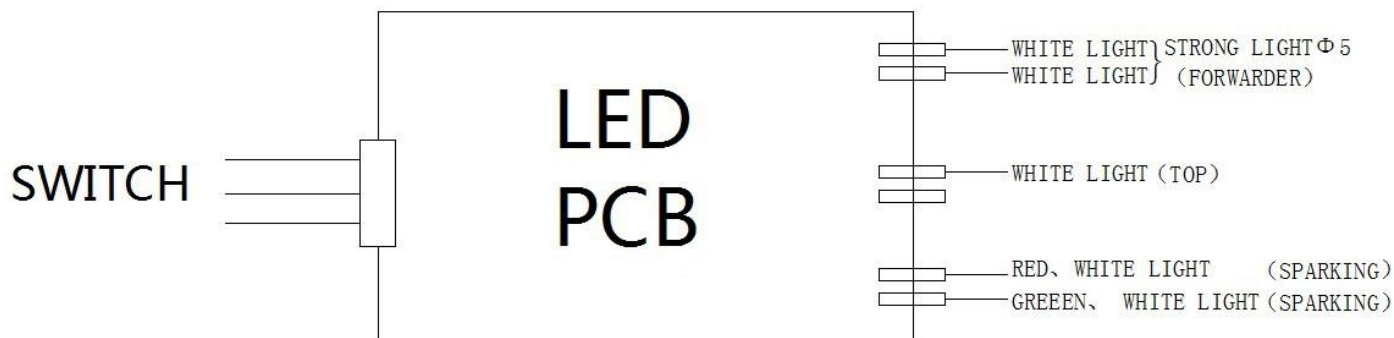

Rudder and tail wheel Installation

Find out the rudder and rudder tube

Insert the rudder tube into rudder.

Connect the rudder onto the fuselage.



Find out the steel as shown, insert it into the rudder and glue it.

Connect the rudder onto the fuselage by two pcs of carbon fiber tubes.

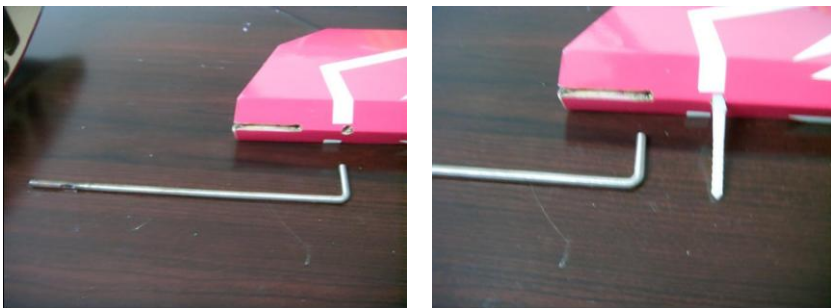

Connect it as shown, totally four pcs of wires.

Always do the wire insert the metal tube twice and scrimp the tube.

Insert the steel into the arm, and use screw to lock the steel with the arms.





There are totally three place for you to install the tail servo. Choose the middle one to pull the rudder and tail wheel.

Find out above wood servo tray, and stick it onto the rudder servo position, to make the rudder servo on a higher level.

The rest two servo hole could be installed with elevator servo.

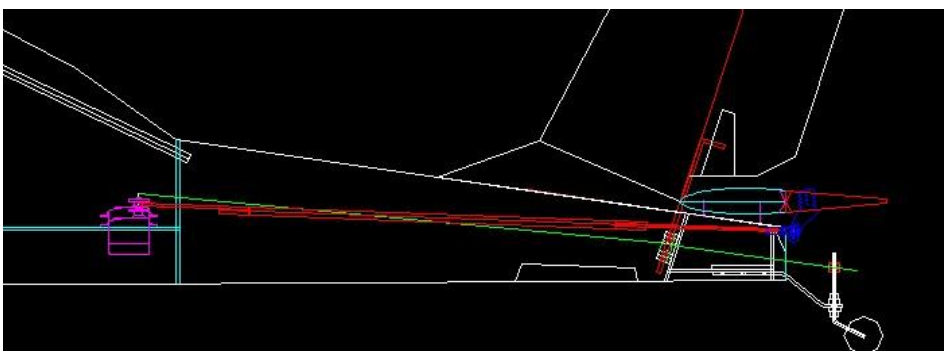
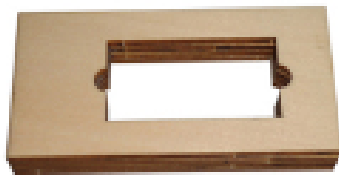

Find out the parts bag for the tail landing gear

Assembly it as shown

Install the tail landing gear into the fuselage tail with screws

Connect one side of the wire with the rudder and tail servo in the fuselage.

And another side to the arm to steel the tail wheel as shown.

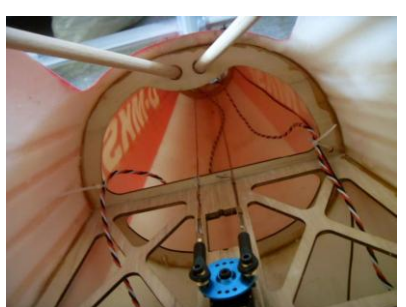

Stabs and Elevator Installation

Install the control horn on the elevators, connect the servo to the control horn by pull-pull wires and ball-links.

Cut out the holes to lock the stabs as shown.

Use self-taps to install the stabs onto the fuselage.

Because the stabs only very little part connected with fuselage, we add a aluminum piece to support the stabs.

Lock the aluminum piece with self-tapped screw onto the fuselage and the stabs.



Connect the servo arm and control horn with pushrod.

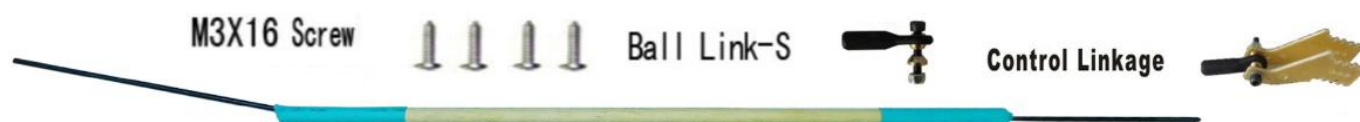

Main Wing Assembly

Parts for Main wing installation



- 1 Remove the covering from the servo position. Find out the slot pre-opened for rudder control horn, remove the film. as shown.
- 2 Fit the control horn into the slot, glue the horns into the aileron of each side.
- 3 Drill holes for the servo mounting screws and harden the wood around the holes with a drop of thin CA.
- 4 Use the safety clips (buy separately) to secure the servo and servo extension connected.
- 5 Put the servo into the servo hole, and mark the position for the screw to fixup the servo. Pull the extension lead through to the root of the wing.

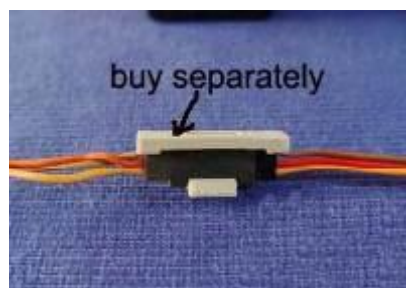

- 6 Drill holes for the servo mounting screws and harden the wood around the holes with a drop of thin CA.

7 Install the control horn. Adjust the horn and servo arm. Fix the horn in place firmly. Install the ball link and push rod . Make sure it's firm and flexible.

8 Repeat the previous steps for the other wing. Please install the wing tube and wing bolts in the final assembly.

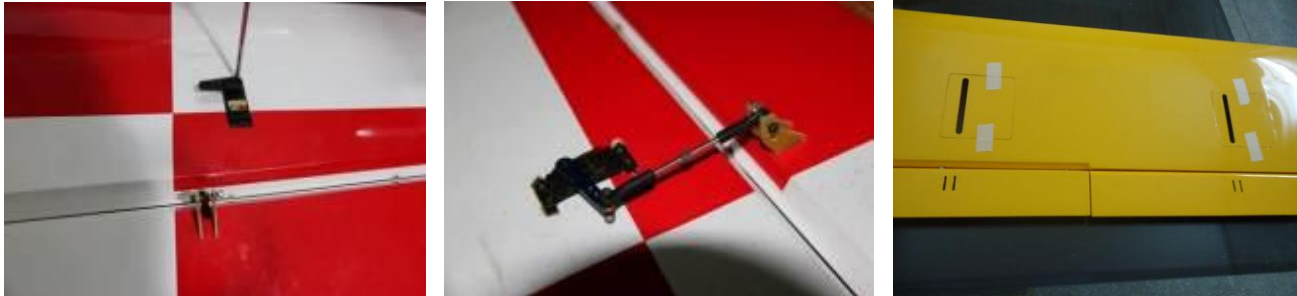

Engine Installation

Pre-marked holes for the engine

1 there marks also how much you need to add to make the right thrust and down thrust (for engine DLE 30).



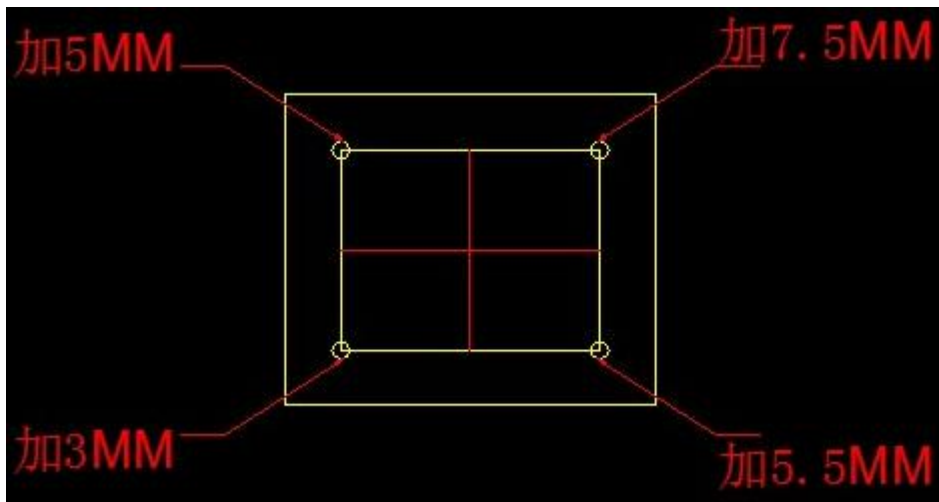

- 2 Insert the bolts through flat fender washers, the firewall and into the engine stand offs. Tighten firmly. Secure mounting bolts nuts with Blue Loctite.
- 3 Use a bit to drill a pushrod exit hole on the firewall in line with the engine carburetor throttle arm.
- 4 Attach the ball link to the throttle pushrod and secure to the carburetor throttle arm with a bolt and nylon lock nut.
- 5 Insert the throttle servo into the servo mounting tray with an output arm forward. Insert the throttle pushrod into the servo arm easy link.
- 6 Mark a line for the throttle servo tray, then glue it to the fuselage.
- 7 Use a drill to drill the servo mounting holes. Install the servo with servo screws.





- 8 Insert the throttle pushrod into the servo easy link. Move the servo arm to the center position. So that carburetor is half open. Tighten the easy link set screw.



Fuel Tank

- 1 Install the inside parts of fuel tank as shown.
- 2 Assembly the outside fuel pipe as shown.
- 3 Tighten the velcro ties secure the fuel tank.

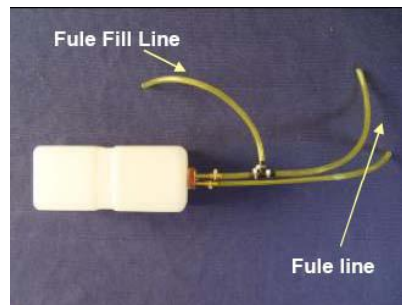
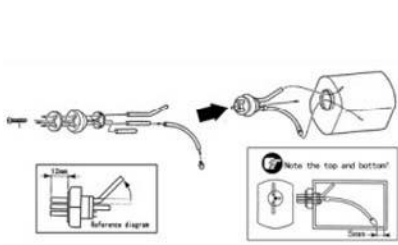

Aero-Tow

- 1 Install the aero-tow and servo onto the plywood 1 with screws.
- 2 Find the right position on the fuselage then cut a hole for the aero-tow. Install the plywood 1 as shown in the photos. Stick it into the fuselage very well.
- 3 Stick the plywood 2 and 3 next to the plywood 1. Make the hole same position as in the fuselage.
- 4 Insert the stick (pushrod) into the aero-tow and connect the other side onto the servo arm.
- 5 Install the rings and wires as shown.



Plywoold 1

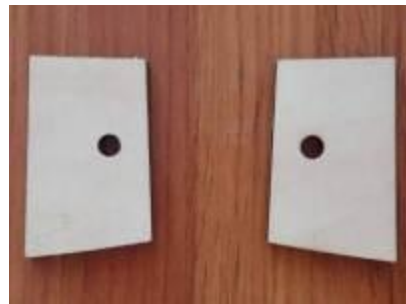

plywood 2 and 3



Stairs

Findout the stair parts and the screws.

Install the wood stair model onto the aluminume support by screws as shown. Lock the stair support onto the fuselage (you need to cut holes to install the stair onto the fuselage).

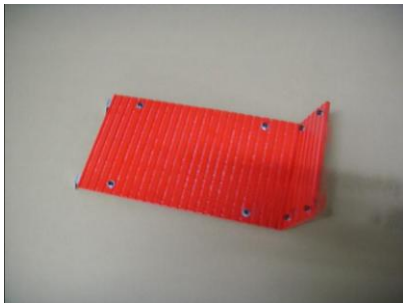
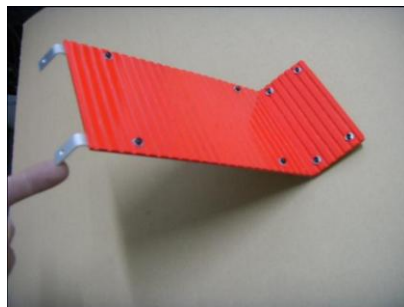

Chairs





Doors Installation

Use screws and hinge install the doors onto the fuselage.

Use magnet on the doors and fuselage. Stick them to the right position.

Find and mark the right positions on the back side of the wings. Cut out the film and stick another pc of magnet on the back of the wings. So that the door could keep open when you need to refill the fuel tank or change the batteries.

Put the dashboard in the right position.

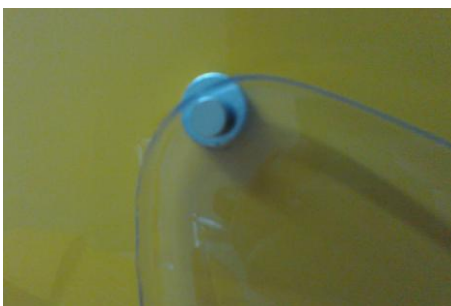

Wood Decoration

Stick the wood decoration into the fuselage place as shown.

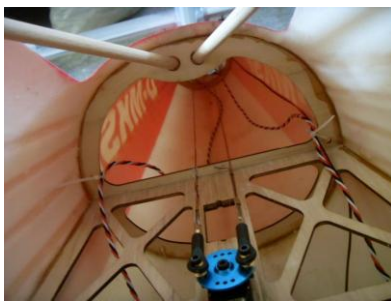
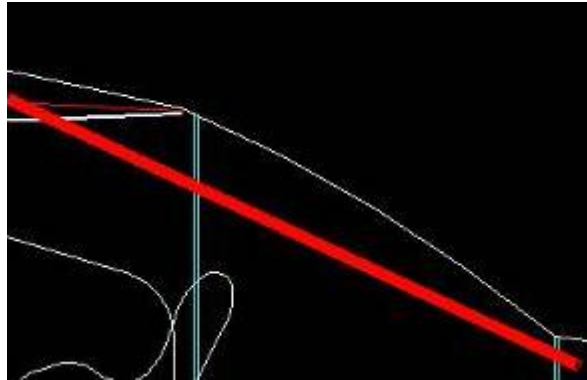
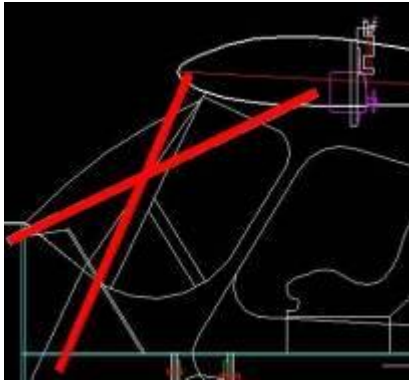

Spinner



Center of Gravity

The center of gravity is on the rear of the wings tube.

Your balance at the CG will determine the final mounting location for batteries. Mount batteries and secure with Nylon zip ties.

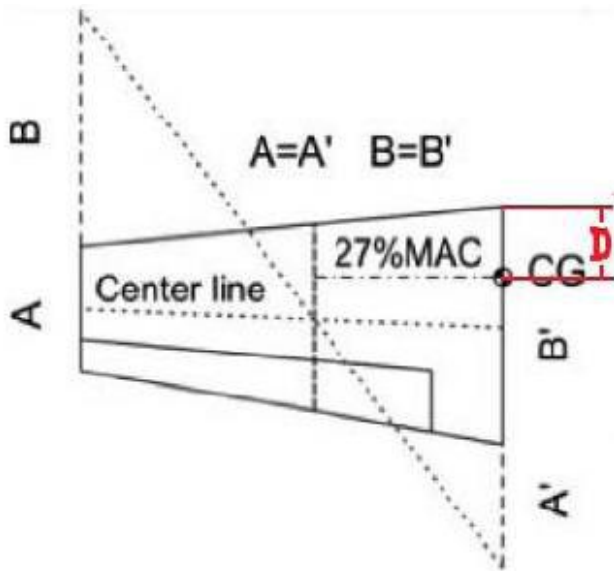
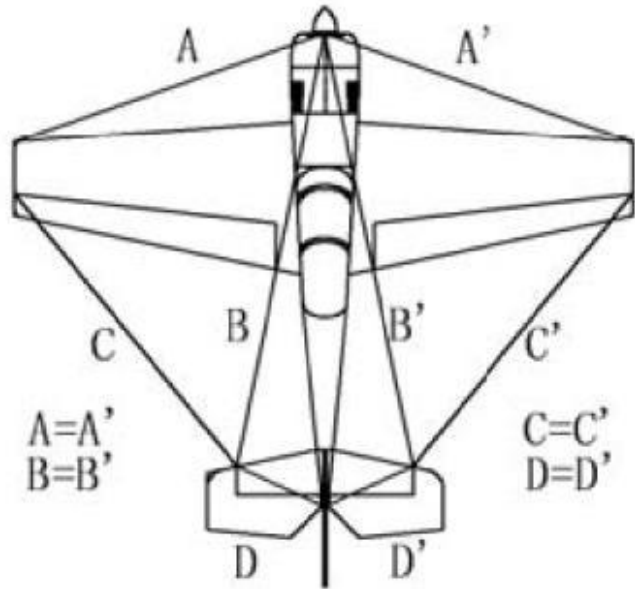

Measure the CG from the leading edge of wing root rib. Adjust the battery pack location. For CG proper position should be at 27% MAC. This recommendation balance point is for your first flights. The CG can be moved around later to fit your personal taste.

Wilga 100cc D = 136 mm

Wilga 50cc D = 116 mm

Wilga 30cc D = 100 mm

Wilga 20cc D = 90mm

Power on to trim your plane.

1. Range check the radio (test whether the Engine/Motor is running or not).
2. Ensure that the servos and control surfaces move smoothly and in the correct direction.
3. Adjust the servo throw. The chart below is the recommended throws for the first flight. You can adjust the servo arms and control horn length later to fit your flying style.

Control Throw:

	Surface	Throws	Exp
Common flying	Ailcron	20 degrees	25%
	Elevator	20 degrees	25%
	Rudder	30 degrees	30%

3 D flying	Aileron	40 degrees	45%
	Elevator	40 degrees	45%
	Rudder	45 degrees	45%

Trail run the Engine to check its stability at high speed and low speed to ensure there are no problems with vibration on the model. Run the motor at high speed about 30 min, check the Engine and make sure the temperature is below the prescription of manufacturer.